

Архитектурно-художественная концепция
станции Московского метрополитена

"ЗАГОРЬЕ"



Местоположение

Липецкая улица

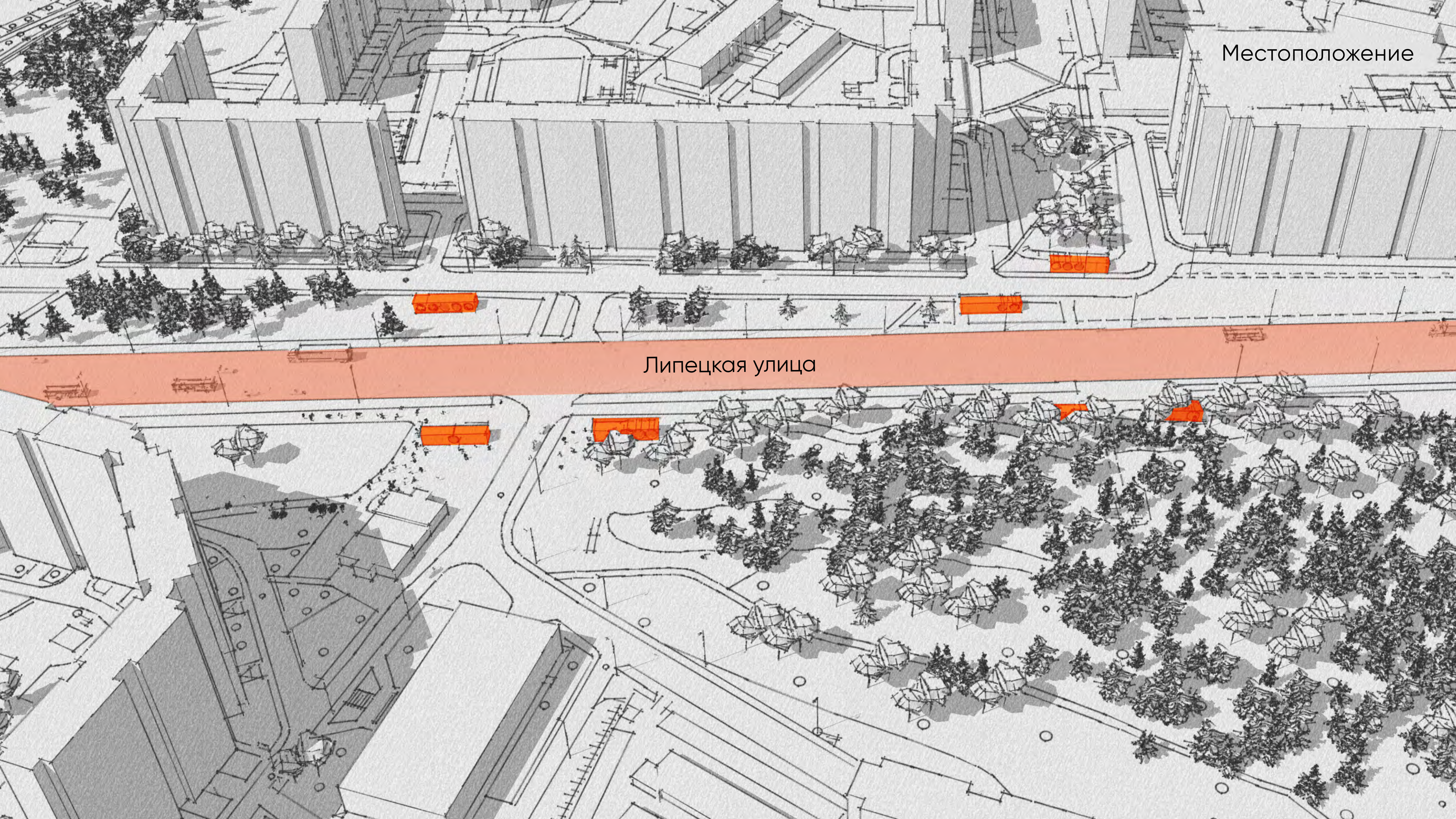

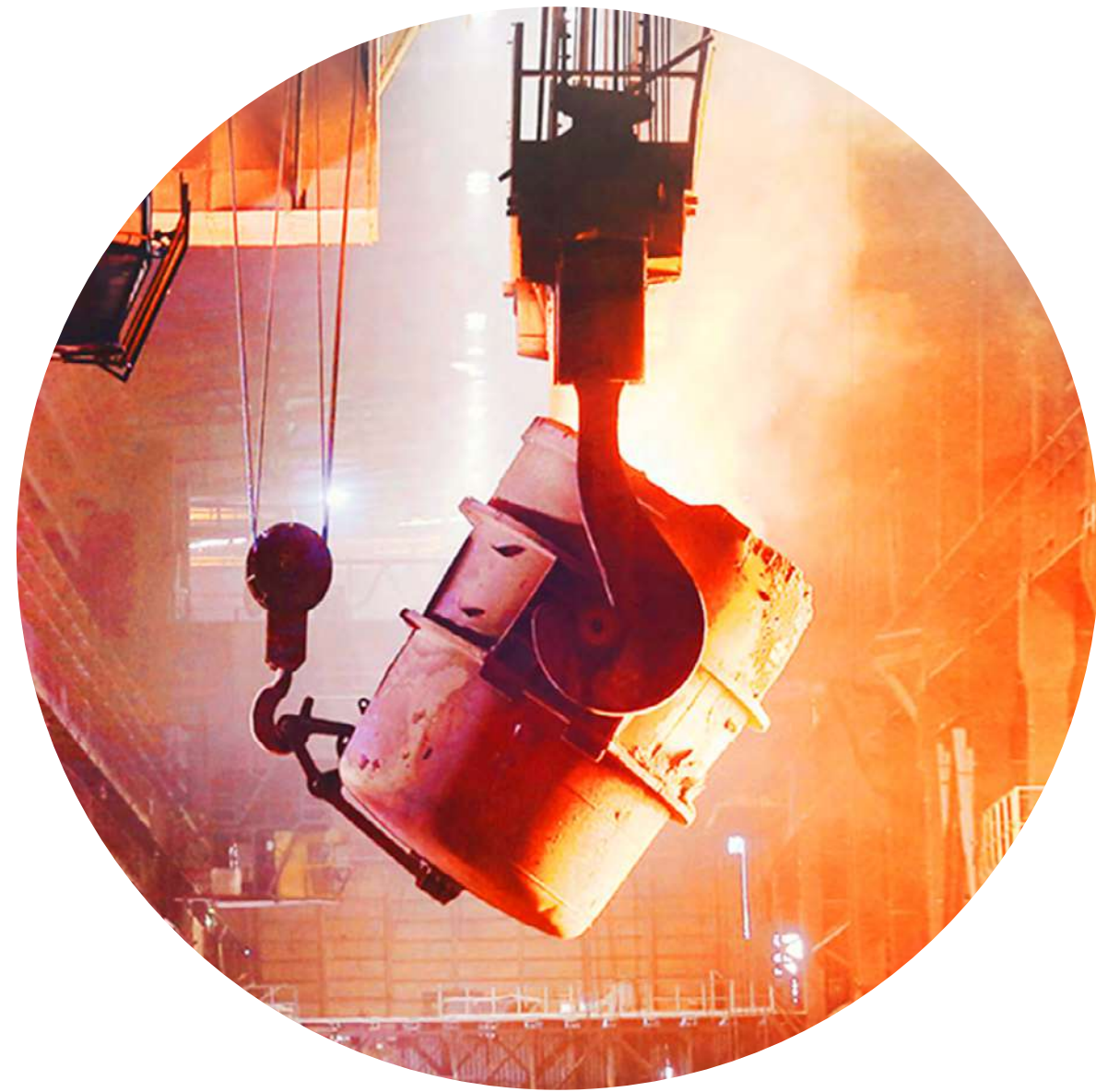

Металлургический завод

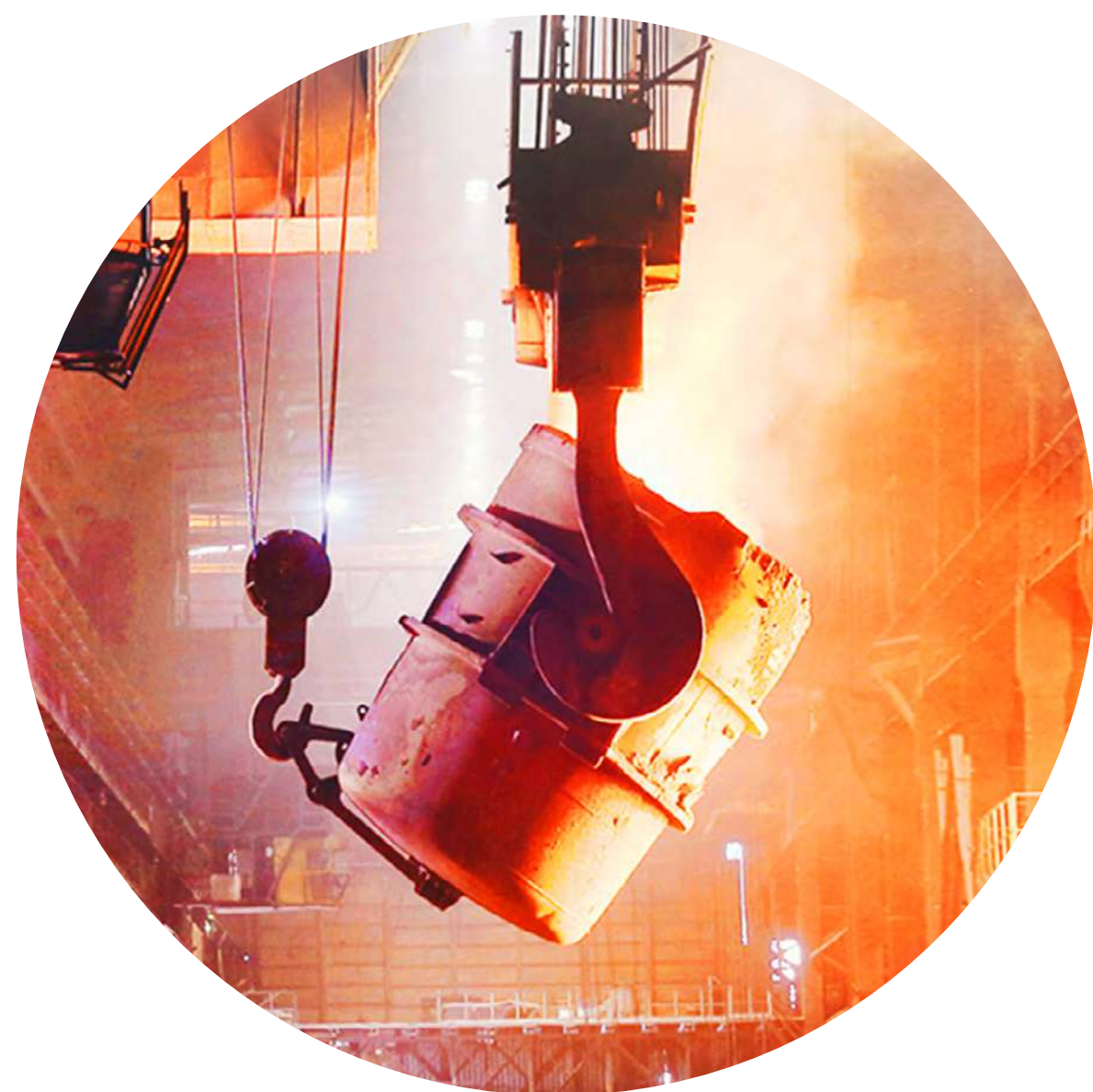

Металлургический завод



Цвет раскалённого металла

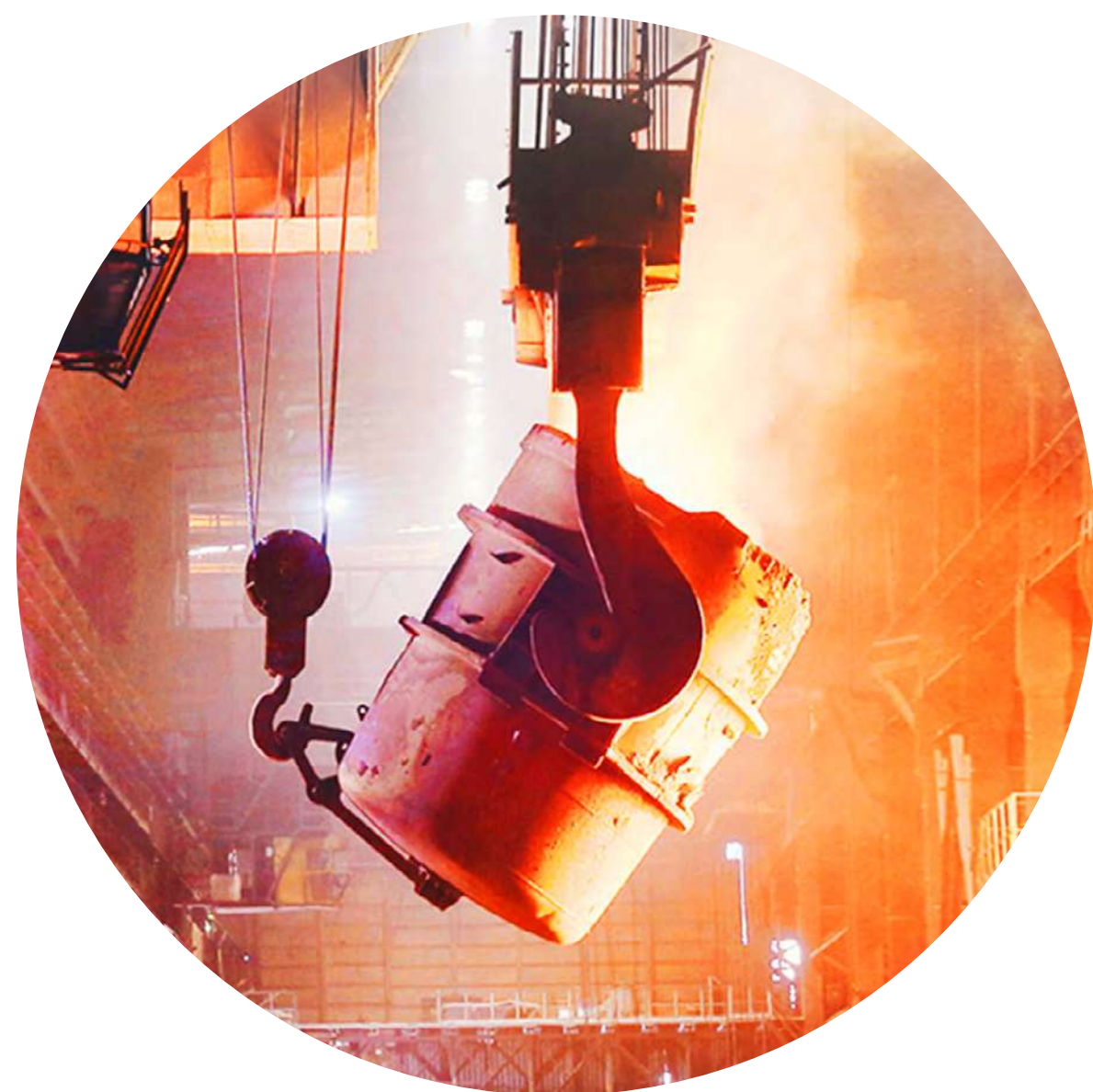

Металлургический завод



Цвет раскалённого металла



Листовой металлопрокат



Нет входа
No Entry

Запрет
Запрет





Перекресток

Типы павильонов



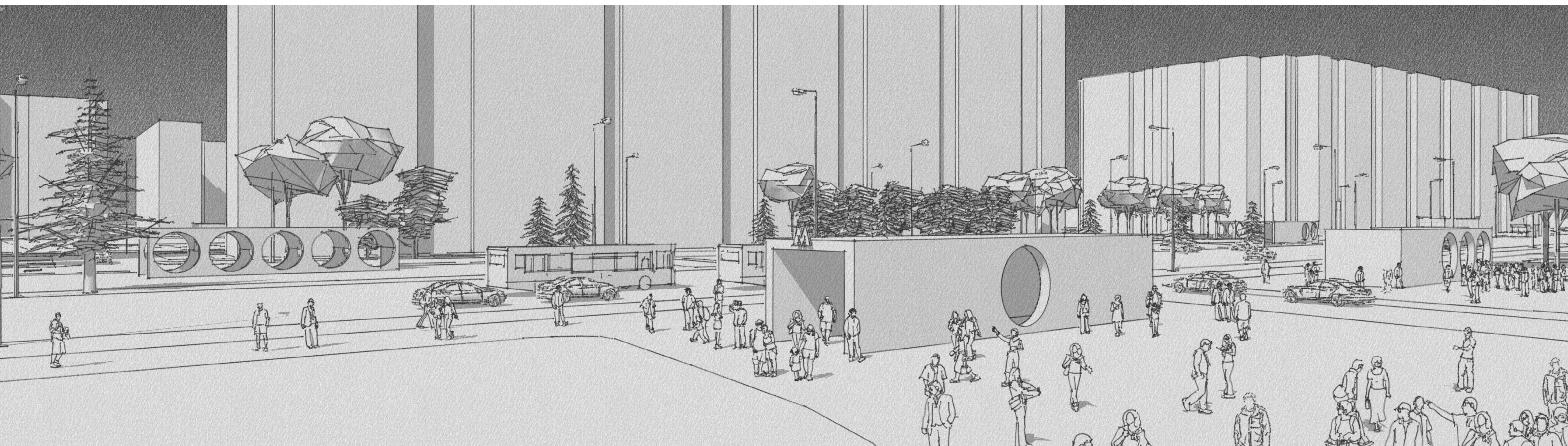
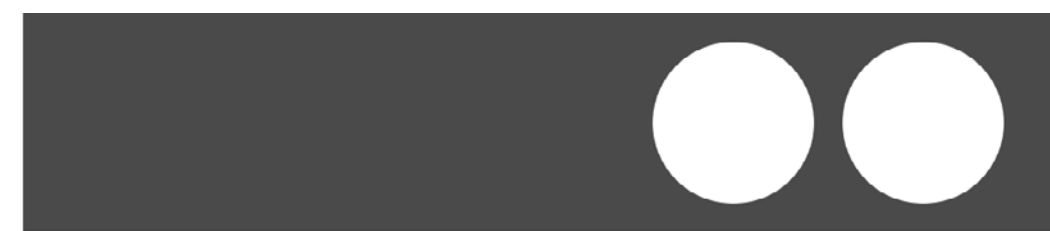

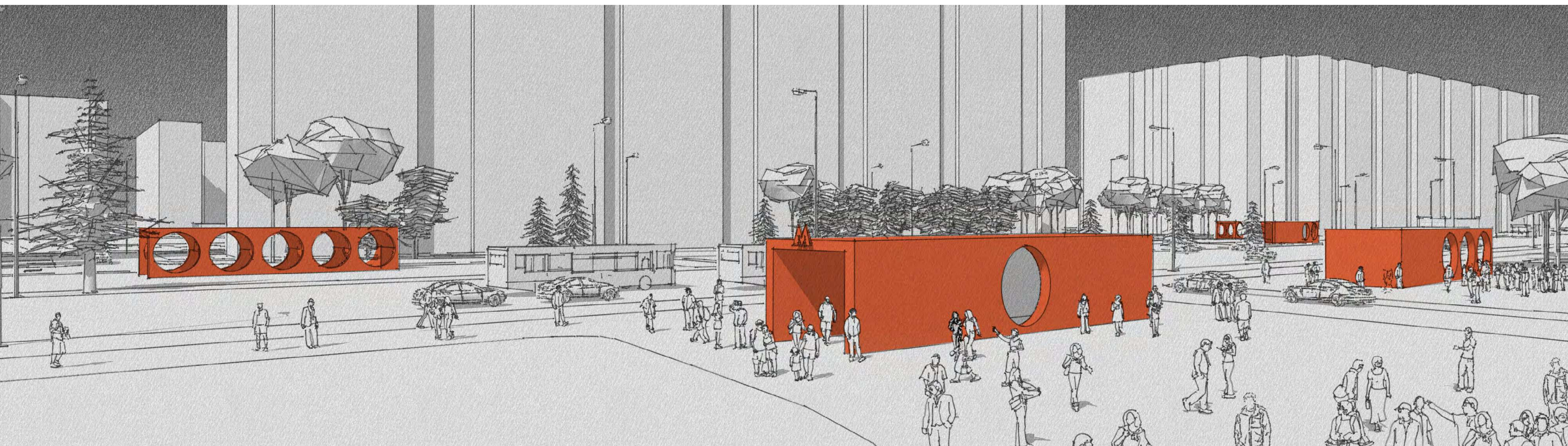
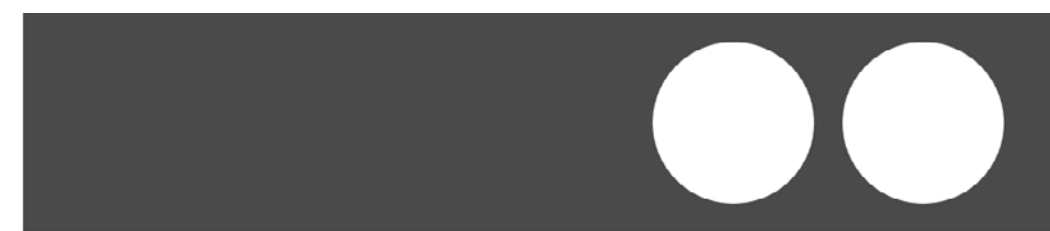





↑
Выход
Way out

ЗАГОРЬ



ЗАГОРЬЕ

Поперечный разрез
платформенного зала



Зона
эскалаторов

↑ 1-3 Выходы
Exit

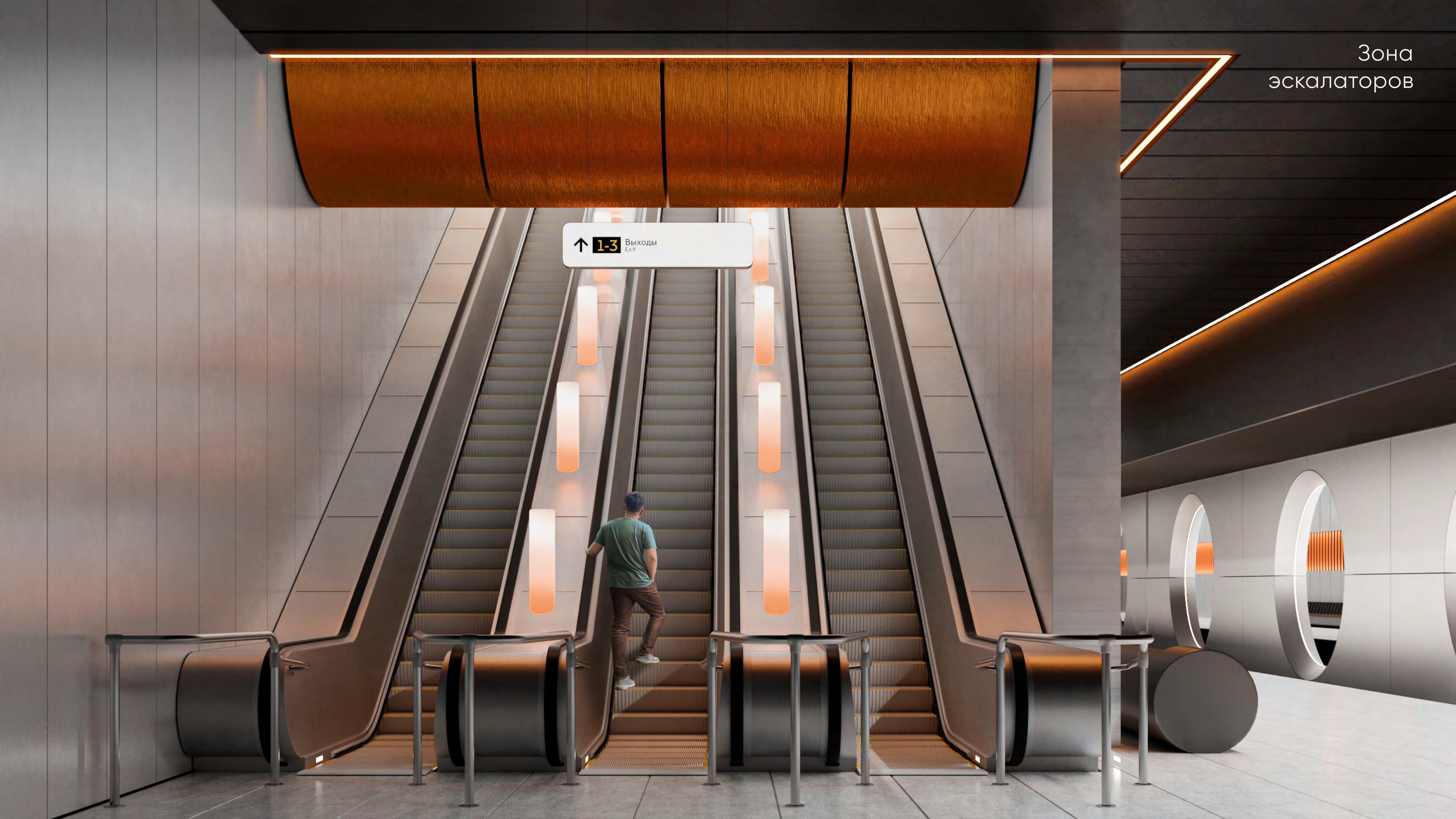

Зона
эскалаторов

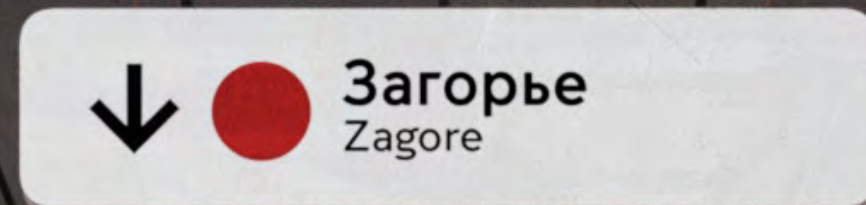

Поперечный разрез
эскалаторного спуска

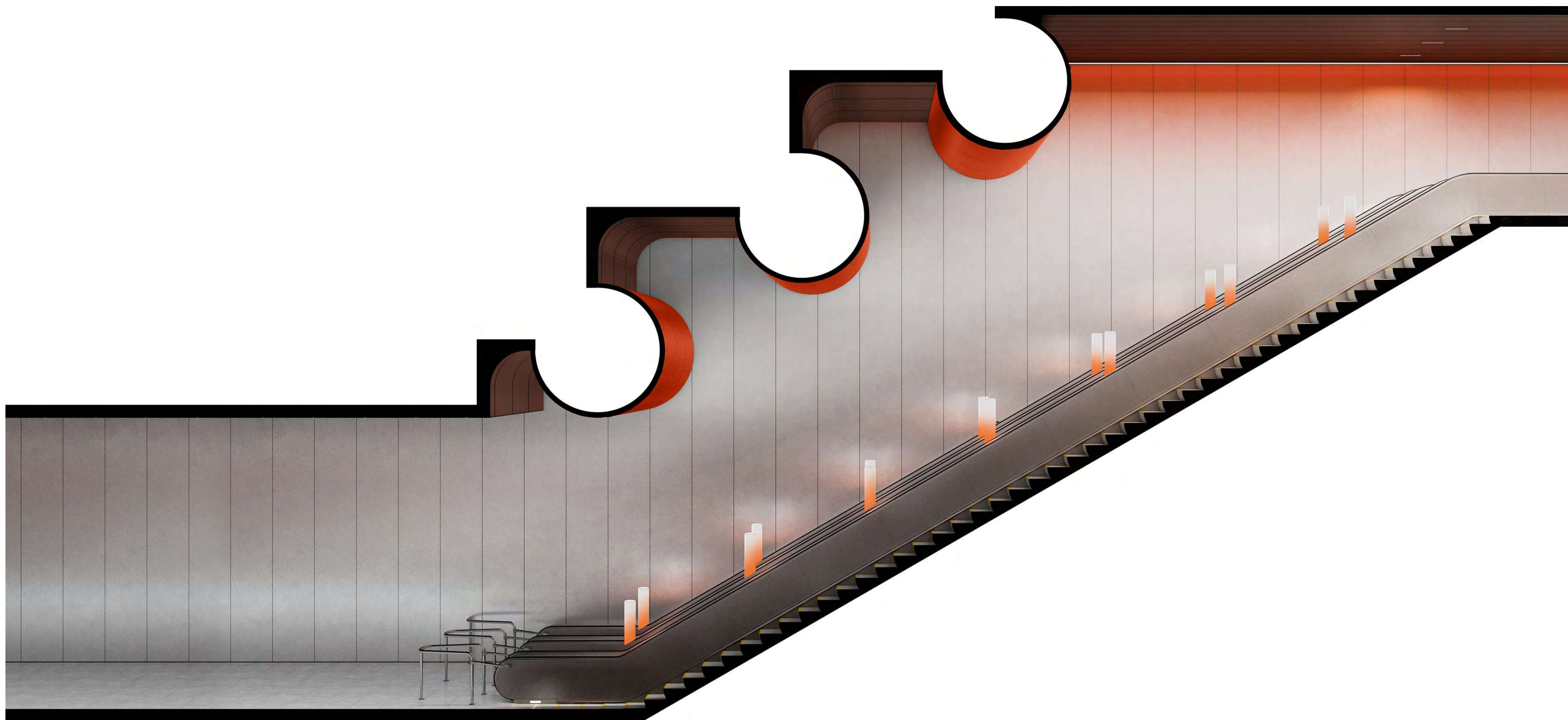

Kassa
Ticket Office

Kassa
Ticket Office

Kassa
Ticket Office

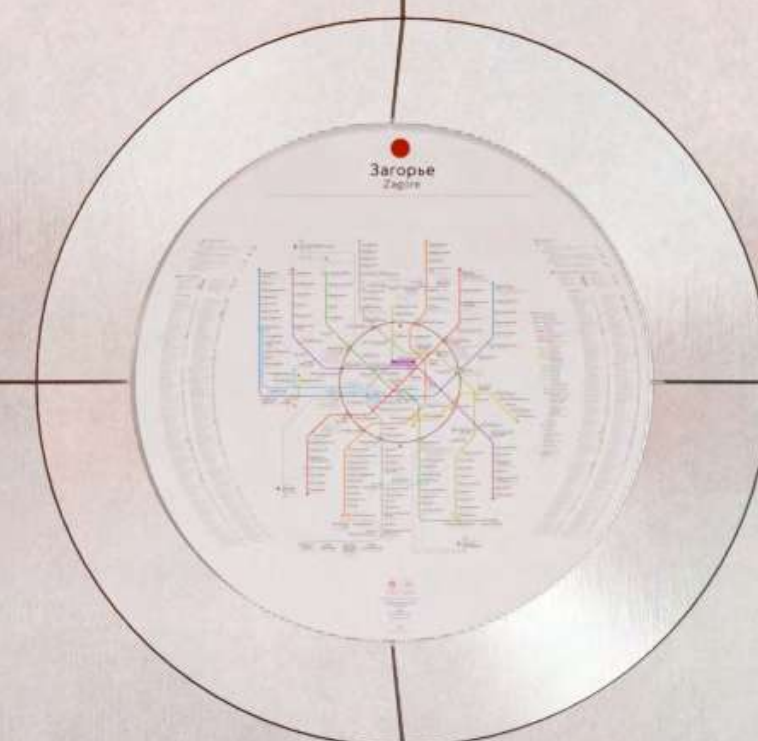
Three ticket office counters are arranged horizontally. Each counter has a white top section with the text 'Kassa Ticket Office' and a small red logo. Below the text is a large orange panel. The counters are set within a white, rounded rectangular frame against a grey wall.



← **1-2** Лебедянская улица
Lebedyanskaya street
Выходы
Exit

Загорьевская улица **3** →
Zagoryevskaya street
Выходы
Exit



← 3 Загорьевская улица
Zagoryevskaya street





Юлия Тряскина
Елена Логоватовская
Илья Смирнов
Александр Бурушенков
Ольга Муйжнек
Тимур Митин
Виктория Есина
Виктор Шабельский

СПАСИБО



Дополнительные материалы



- 1 Проектируемая станция метро
- Бирюлёвская линия метро
- Замоскворецкая линия метро
- Серпуховско-Тимирязевская линия метро
- Третье транспортное кольцо
- Мкад

План и продольный разрез по платформе

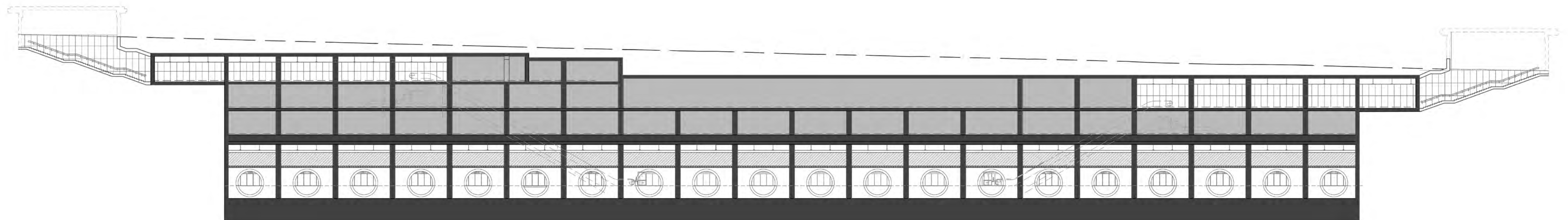
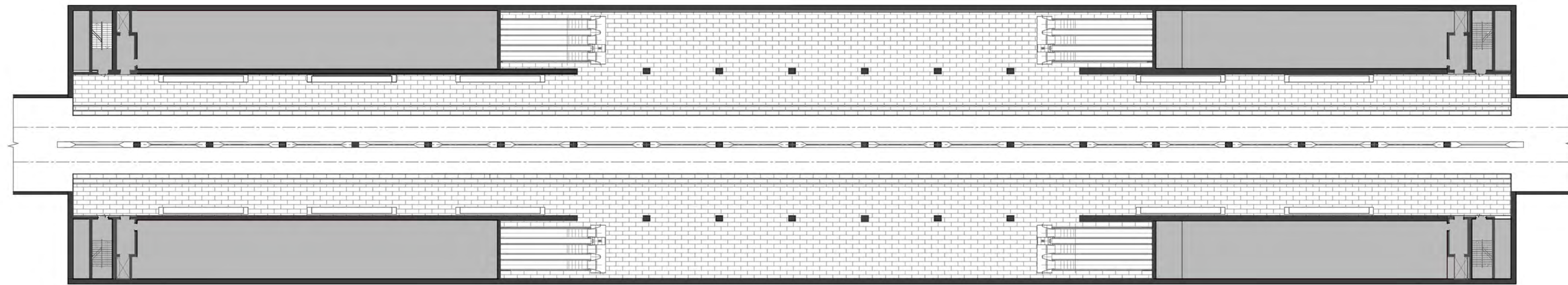

План в уровне вестибюлей

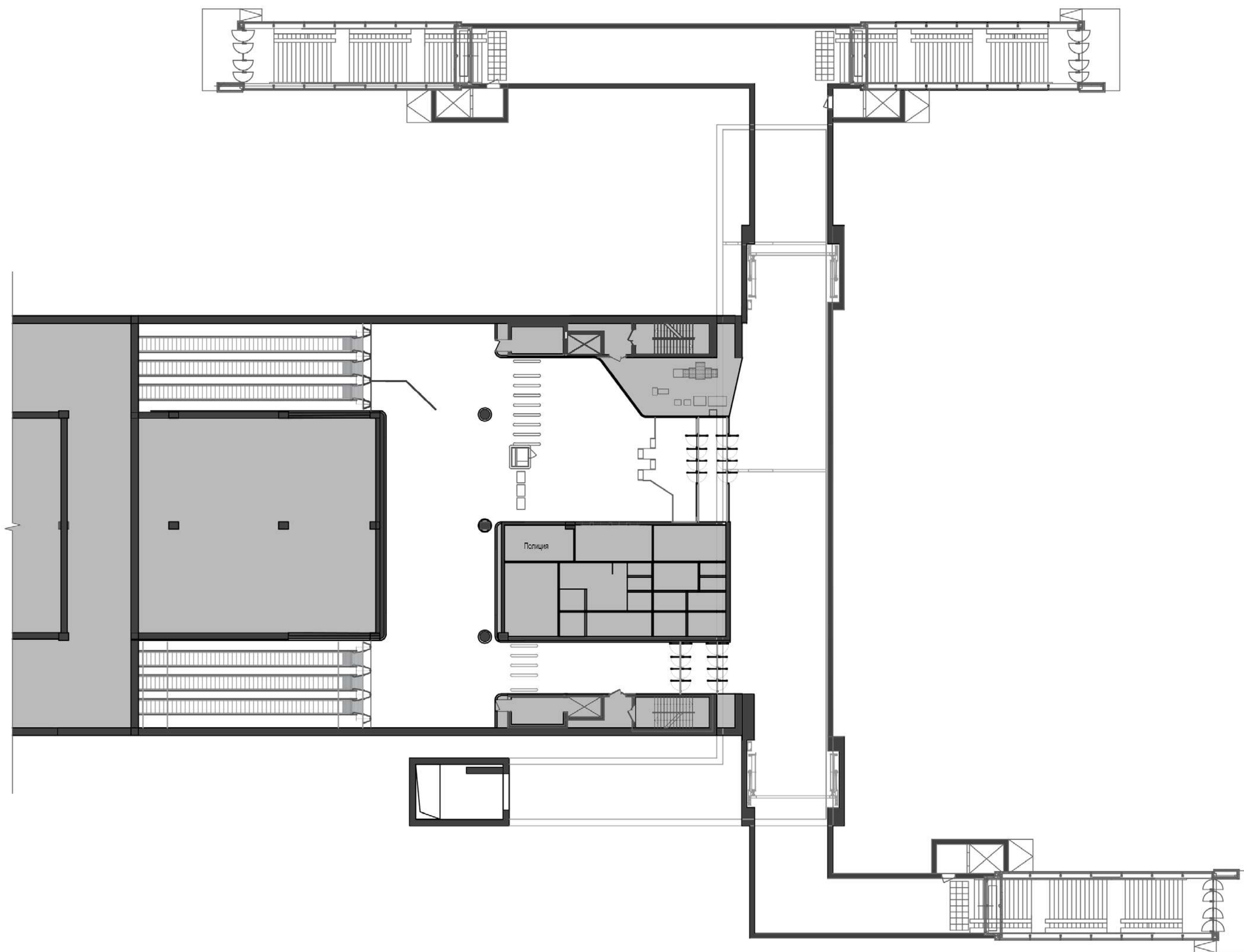

Принципиальная схема устройства финишной отделки

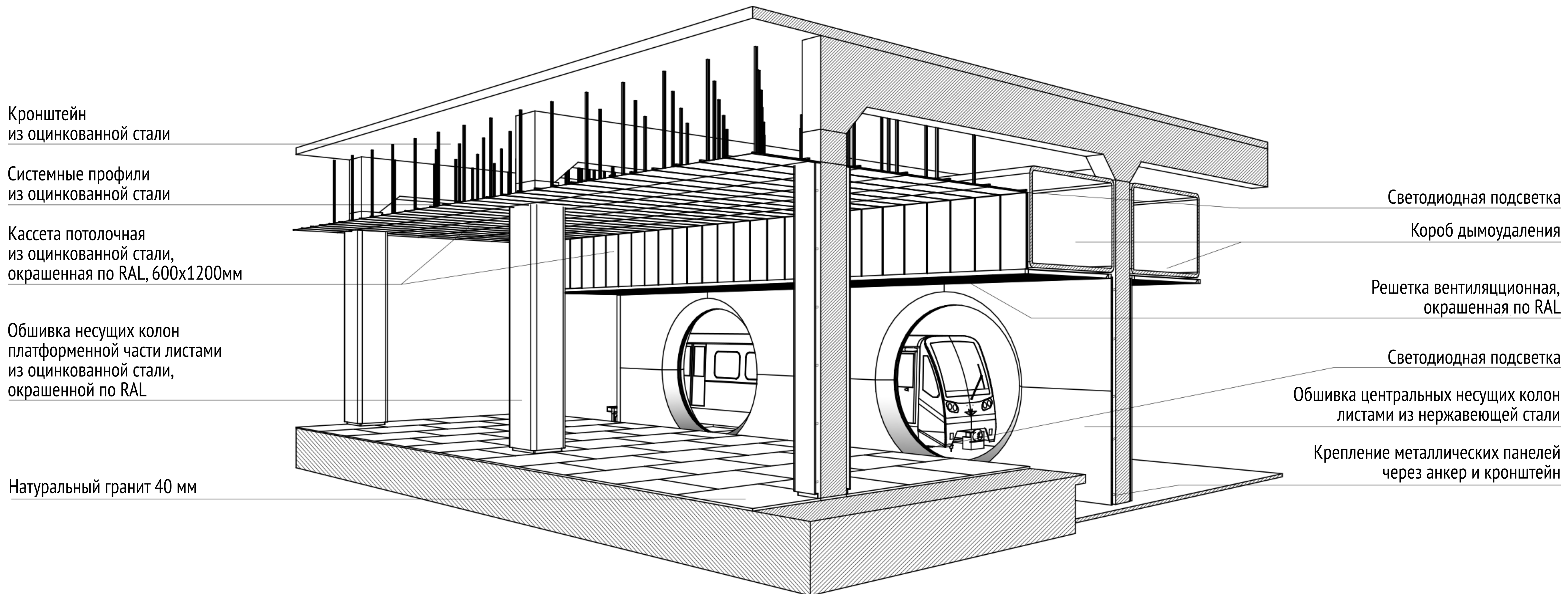

Скамьи платформенного зала

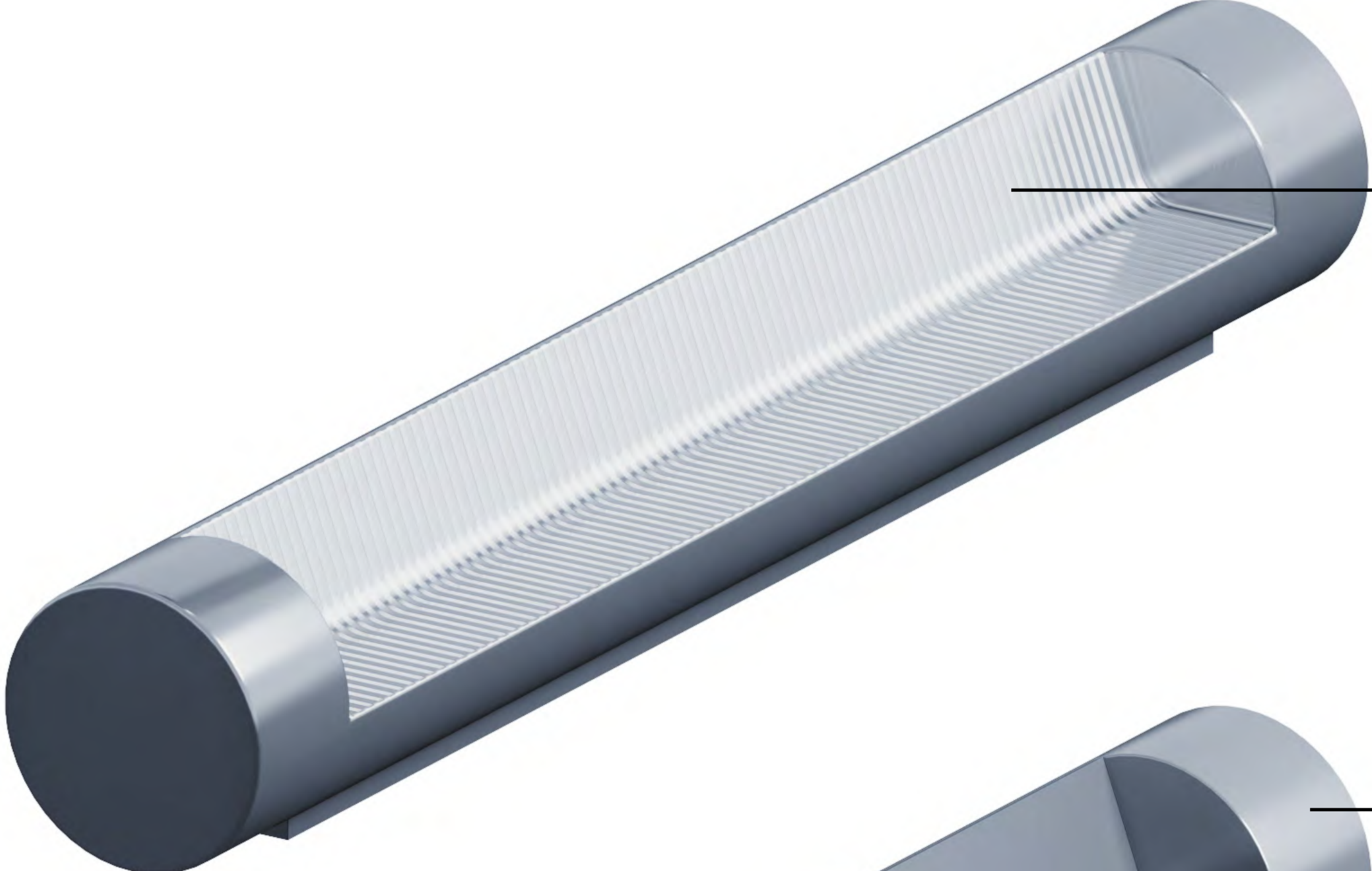

Нержавеющая сталь
с подогревом сиденья

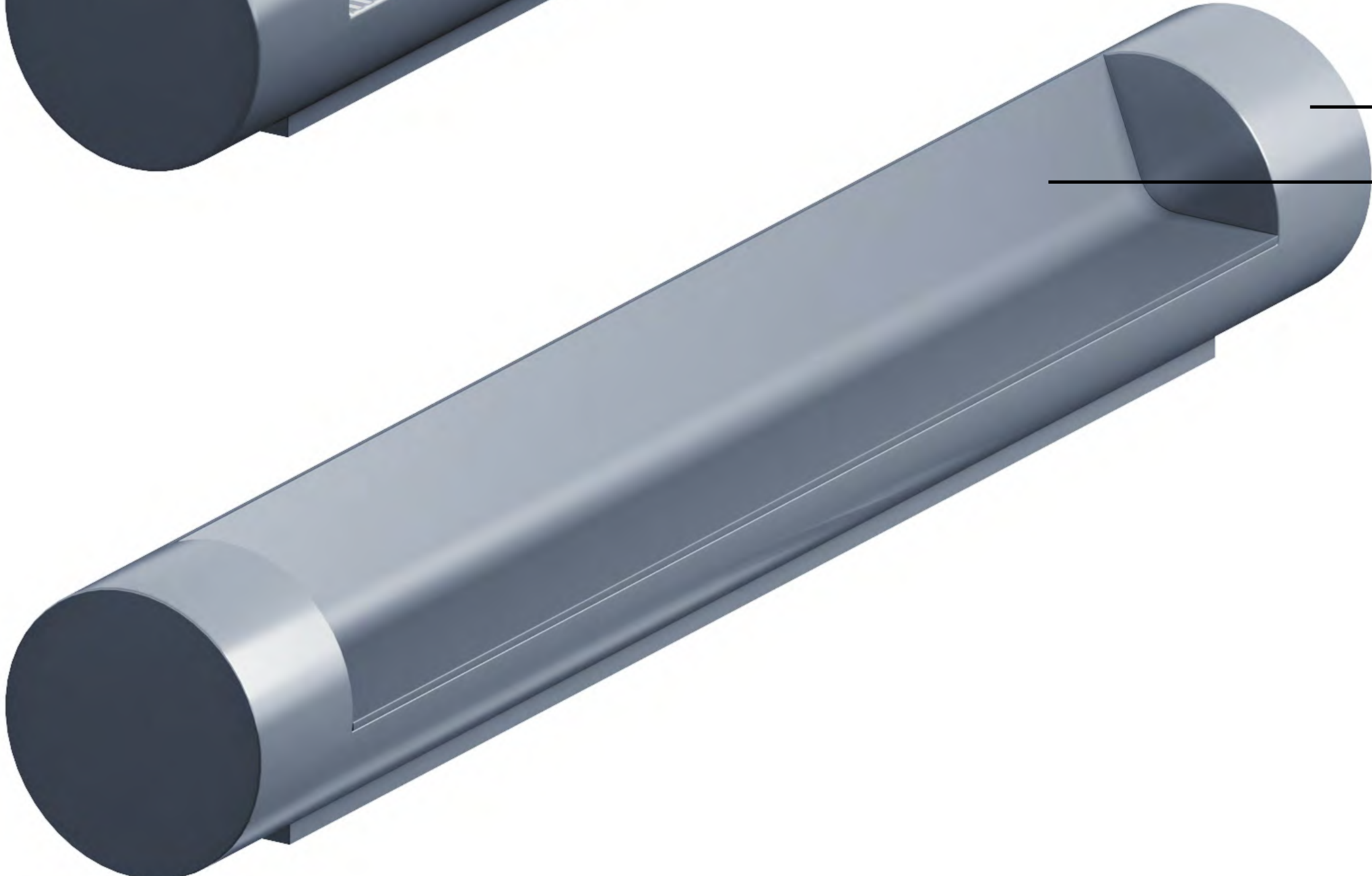

Нержавеющая сталь
Стеклопластик